

# DOUBLE SYSTEMS

## SYSTEM 87

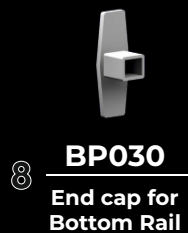
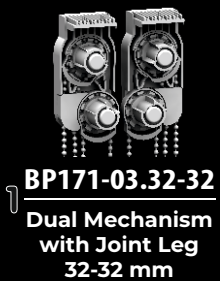
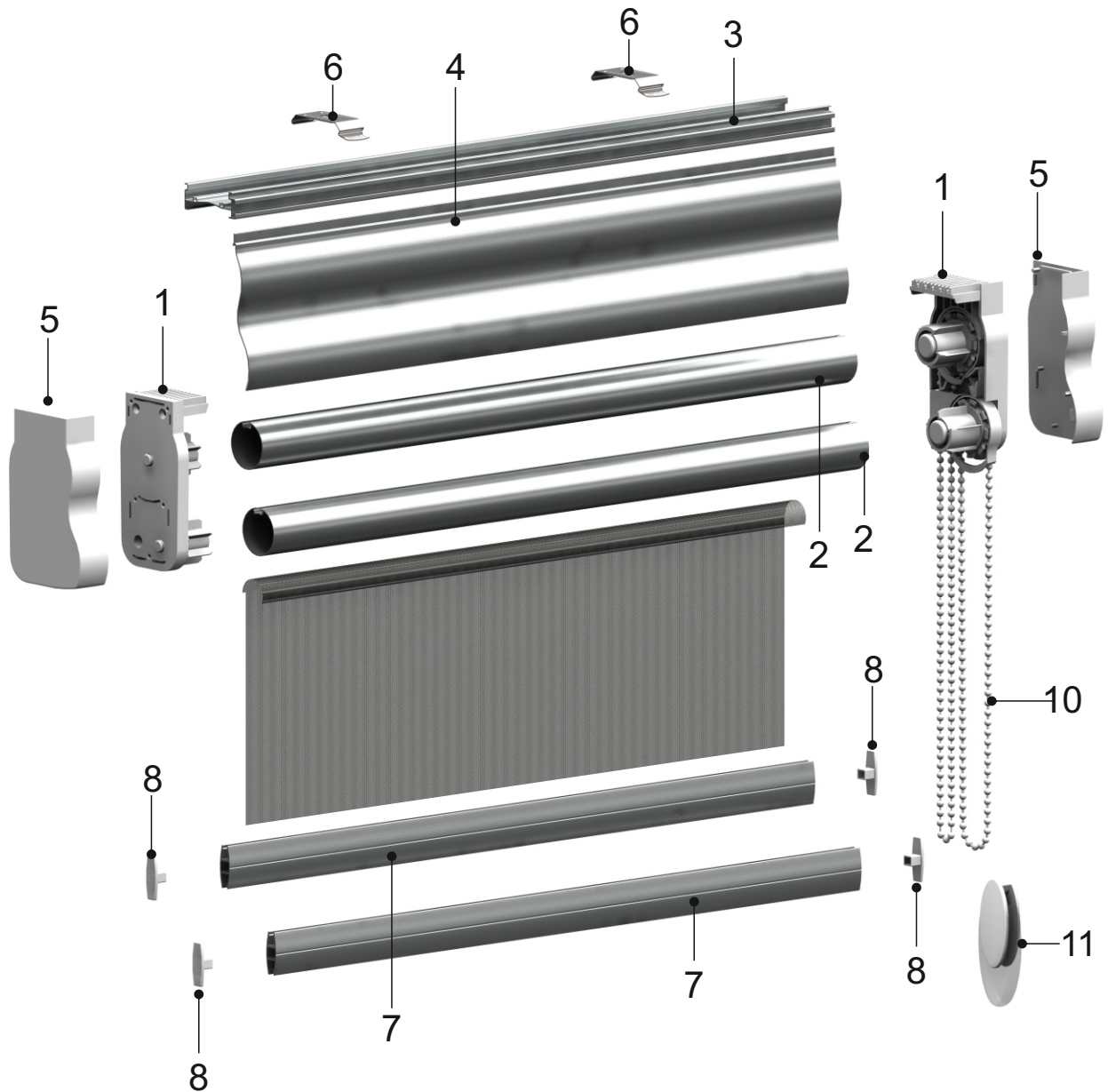

# SYSTEM 87

## TECHNICAL DETAILS

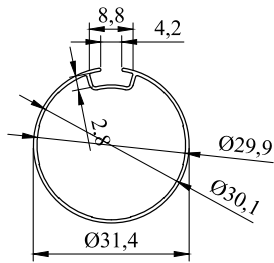

**BP041-03**

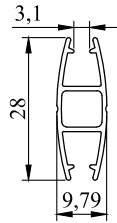

**BP042**

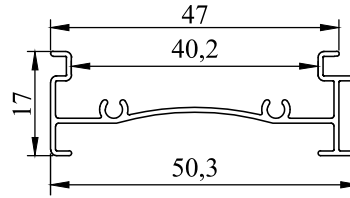

**BP076-02**

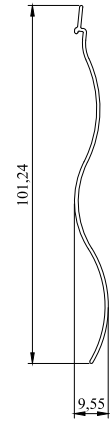

**BP190**

## ALTERNATIVES



**BP187**

Joint Leg for Dual System

option available