

CLOSED TYPE SYSTEMS

SYSTEM 181

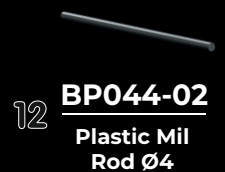
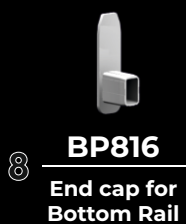
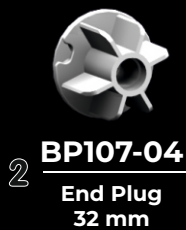
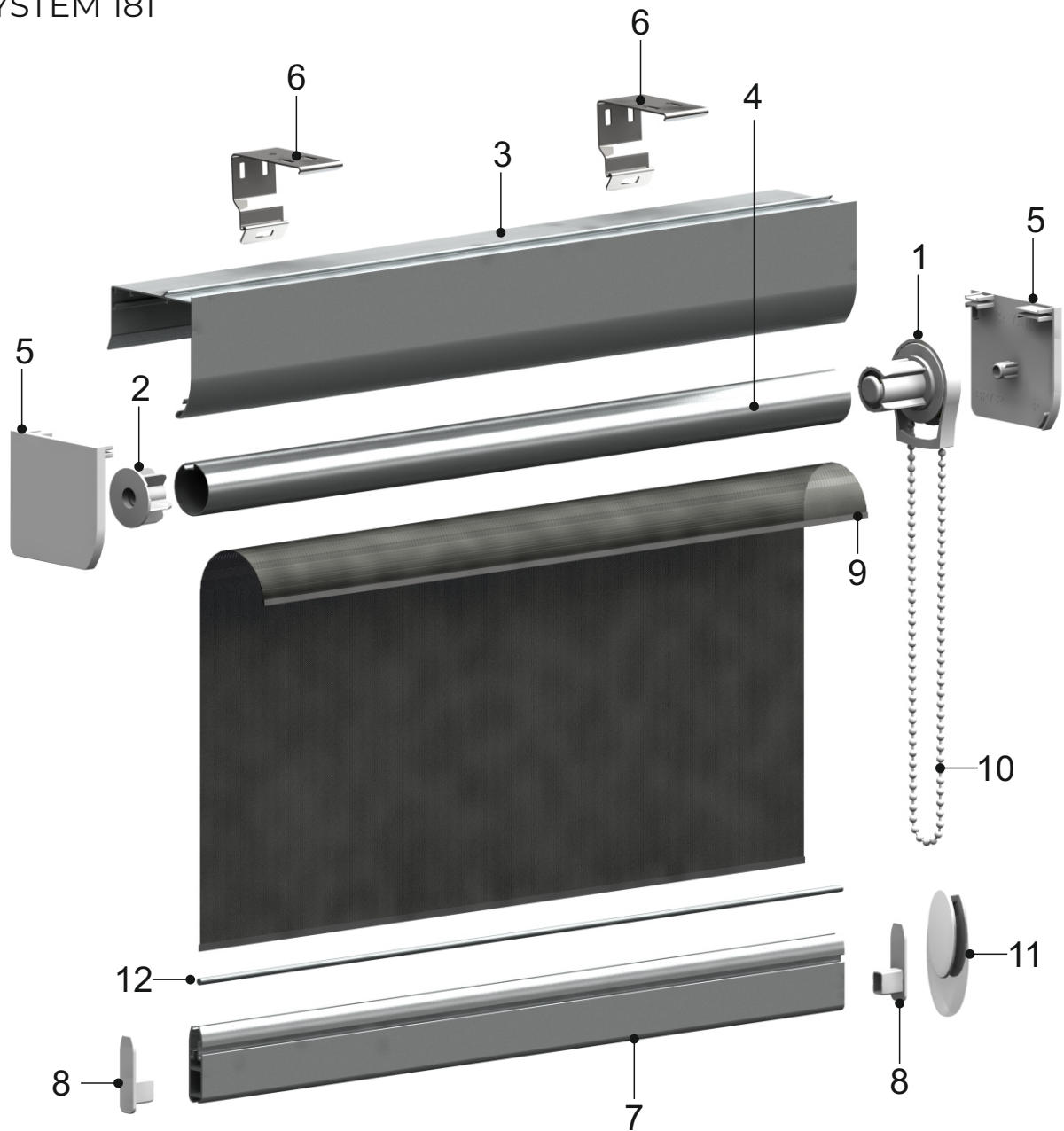

SYSTEM 181

TECHNICAL DETAILS

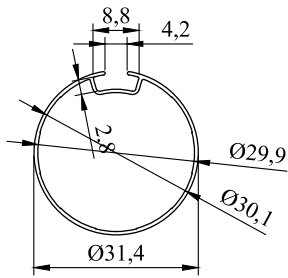

BP041-03

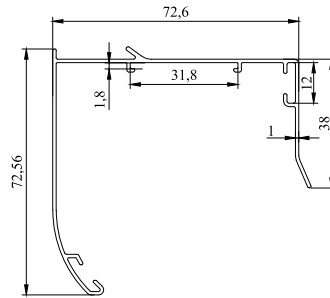

BP731

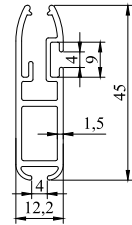

BP815.M