

MINI SYSTEMS

SYSTEM 42-1

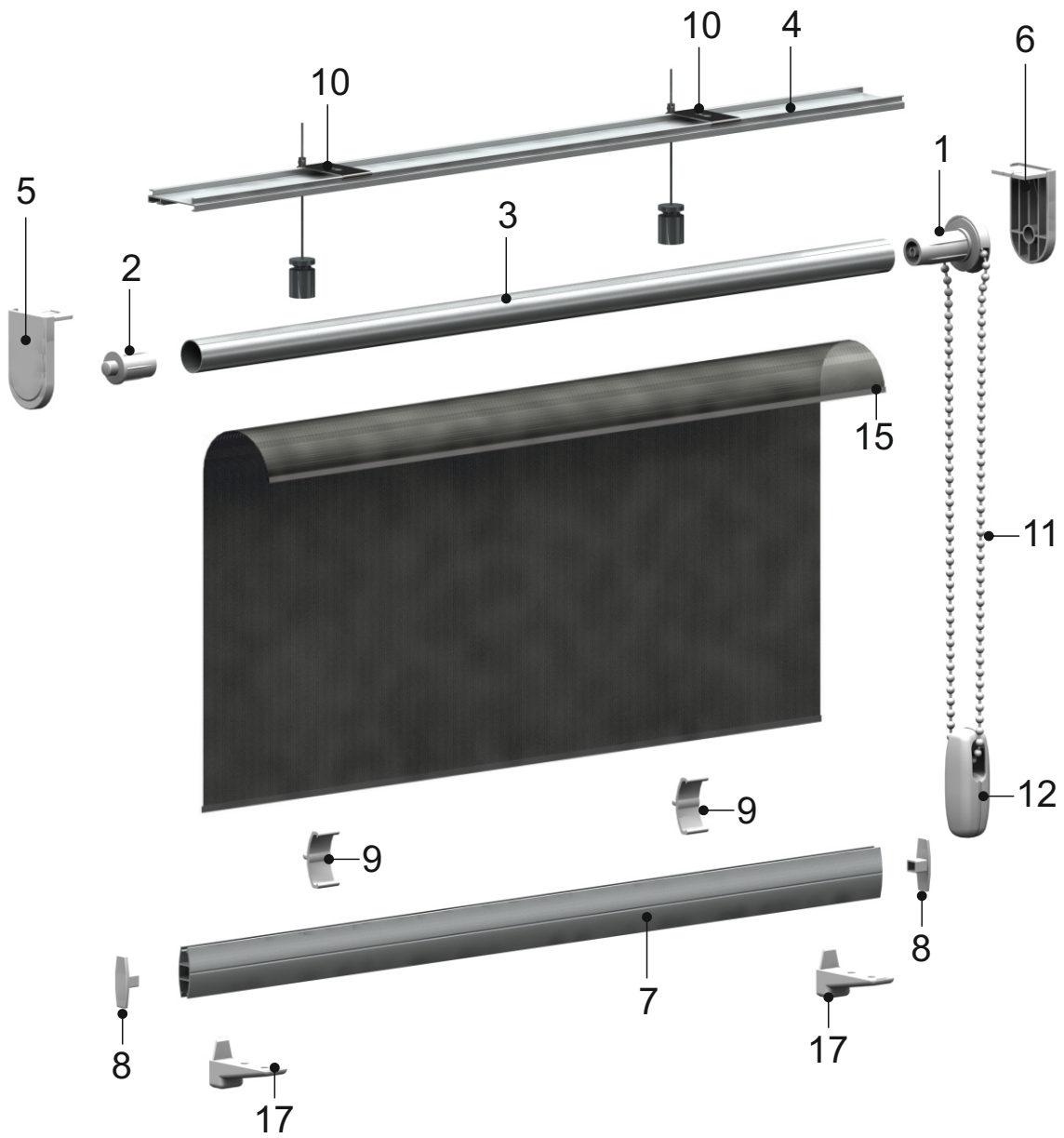

1 **BP214**
Mechanism
16 mm Mini



2 **BP215**
End Plug for
Ø16 mm Tube

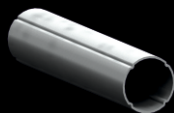

3 **BP041-09**
Aluminium
Tube Ø16

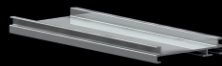

4 **BP031-02**
Aluminium
Headrail Profile
16 mm

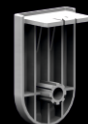

5 **BP500-01.M**
Plastic Side
Bracket

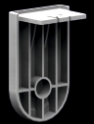

6 **BP500-02.M**
Plastic Side
Bracket

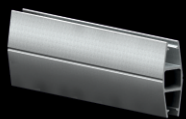

7 **BP042**
Aluminium
Bottom Rail



8 **BP030**
End cap for
Bottom Rail



9 **BP136**
Clip for Guide
Wire
for Bottom Rail

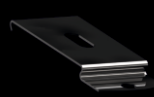

10 **BP143**
Steel
Installation
Bracket 38 mm



11 **BP020**
Chain



12 **BP198**
Chain Weight

SYSTEM 42-1

TECHNICAL DETAILS

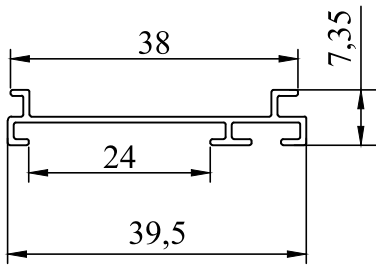

BP031-02

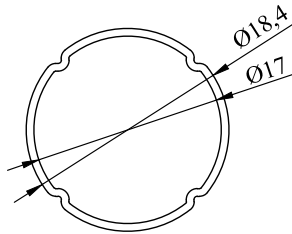

BP041-09

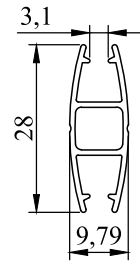

BP042

