

MINI SYSTEMS

SYSTEM 41

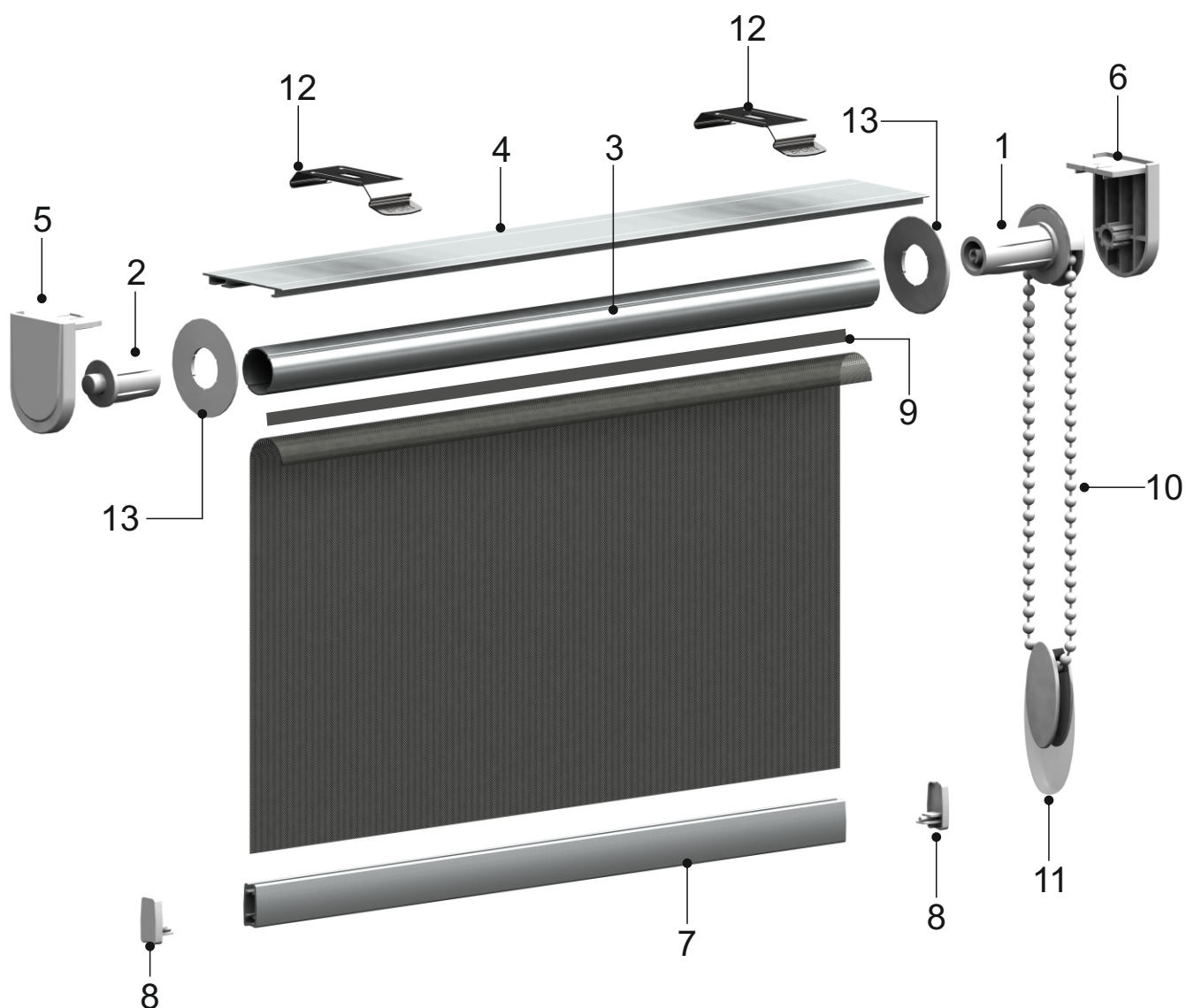

1 **BP214**
Mechanism
16 mm Mini



2 **BP215**
End Plug for
Ø16 mm Tube

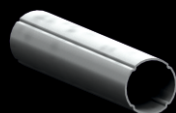

3 **BP041-09**
Aluminium
Tube Ø16

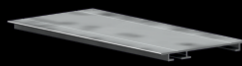

4 **BP031-01**
Aluminium
Headrail Profile
16 mm



5 **BP212-01.S**
Plastic Side
Bracket



6 **BP212-02.S**
Plastic Side
Bracket

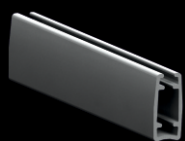

7 **BP234**
Aluminium
Bottom Rail



8 **BP237**
End cap for
Bottom Rail



9 **BP043-01**
Plastic Tape
7 mm



10 **BP020**
Chain



11 **BP270-01**
Chain Weight

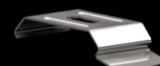

12 **BP054**
Steel
Installation
Bracket



13 **BP798**
Pul
38x15.7 mm

SYSTEM 41

TECHNICAL DETAILS

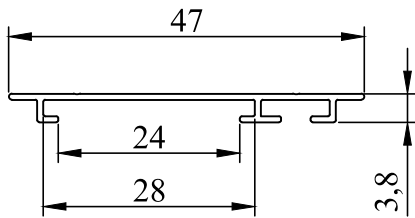

BP031-01

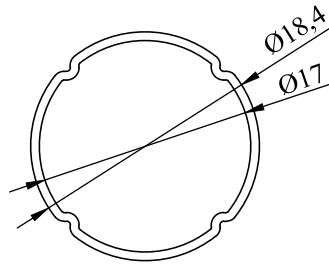

BP041-09

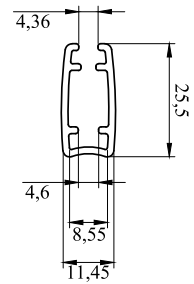

BP234