

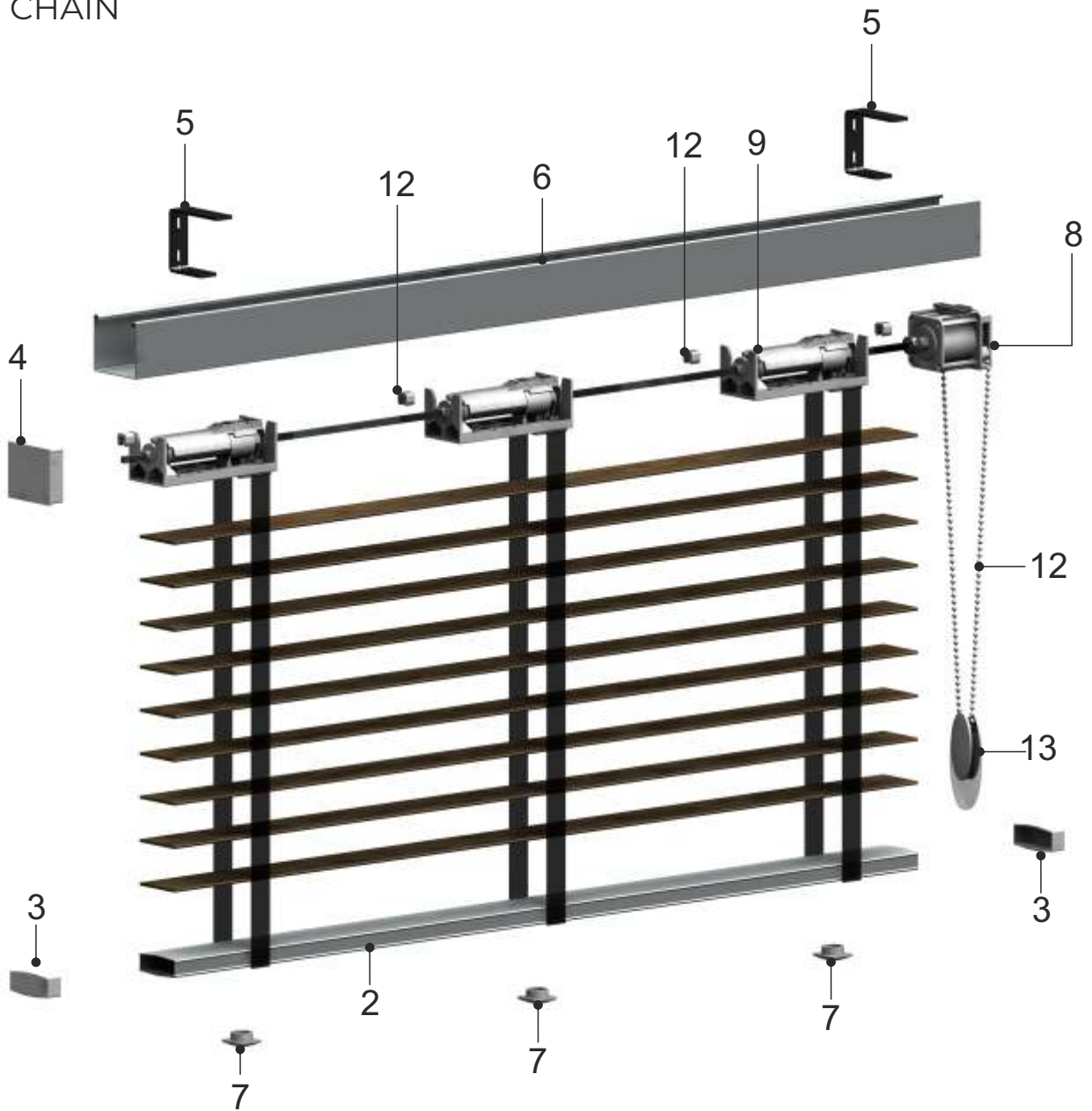











VENETIAN BLINDS SYSTEM

CHAIN



- | | | | | | |
|---|---|---|--|---|---|
|  |  |  |  |  |  |
| 1 BP496
6x6 Square
Aluminium
Inner Rod | 2 BP587
Bottom Rail | 3 BP588
End cap for
Bottom Rail | 4 BP1263
End cap for
Headrail | 5 BP1028
U Shape
Installation Bracket
(BP1029 - BP1030) | 6 BP1029
Headrail |
|  |  |  |  |  |  |
| 7 BP1239
End cap for
Tape | 8 BP1257
Square
Clutch | 9 BP1259
Tape /
Cord roller | 10 BP020
Chain | 11 BP270-01
Chain Weight | 12 BP1299
Stopper |

VENETIAN - CHAIN SYSTEM

TECHNICAL DETAILS

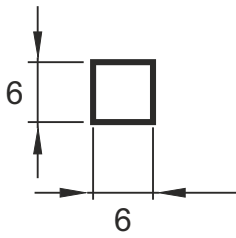

BP496

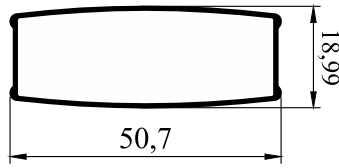

BP587

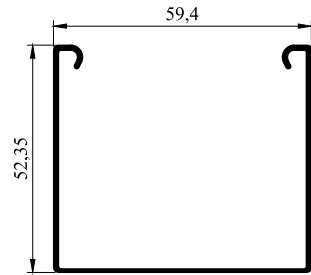

BP1029